



# Chemical Compatibility of HP 3D High Reusability PA12 with Automotive Fluids

Author: ATC team

November 2018



©Copyright 2018 HP Development Company, L.P. The information contained herein is subject to change without notice

The information contained herein is provided for information purposes only. The only terms and conditions governing the sale of HP 3D printer solutions are those set forth in a written sales agreement. The only warranties for HP products and services are set forth in the express warranty statements accompanying such products and services. Nothing herein should be construed as constituting an additional warranty or additional binding terms and conditions. HP shall not be liable for technical or editorial errors or omissions contained herein and the information herein is subject to change without notice.

## Contents

1. Executive summary.....	2
2. Applications for MJF-printed parts.....	4
3. Test Overview .....	5
3.1. Experiment design.....	6
4. Test Results .....	8
4.1. Visual Checks.....	8
4.2. Mechanical Testing.....	10
4.3. Weight Variation .....	13
5. FAQ (Internal Only) .....	14
6. References .....	15
7. Appendix.....	15

## 1. Executive summary

The main purpose of this technical paper is to **validate an initial check of chemical compatibility of HP 3D High Reusability PA12 with various fluids found in the automotive industry**, as part of characterizing the technical feasibility of this material for fluid management applications.

However, it is worth keeping in mind that no short-term test can directly simulate all the environments of a particular end-use application. End-use testing of production parts is the only definitive method of establishing the suitability of a particular plastic part for a specific application.

Chemicals can affect visual, dimensional and mechanical properties. Therefore, properties such as **tensile strength, Young’s modulus, elongation at breakpoint, weight variation and surface appearance** have been evaluated in this study in order to evaluate for possible chemical attacks.”

The key findings of the investigation try to answer the following questions:

- Is PA12 chemically compatible with these fluids?
- How are mechanical properties affected?
- How are look & feel affected?
- Is there any weight variation?
- Has any degradation occurred in terms of a chemical reaction, stress cracking or plasticization/solvation?

©Copyright 2018 HP Development Company, L.P. The information contained herein is subject to change without notice

The information contained herein is provided for information purposes only. The only terms and conditions governing the sale of HP 3D printer solutions are those set forth in a written sales agreement. The only warranties for HP products and services are set forth in the express warranty statements accompanying such products and services. Nothing herein should be construed as constituting an additional warranty or additional binding terms and conditions. HP shall not be liable for technical or editorial errors or omissions contained herein and the information herein is subject to change without notice.

Table 1 shows a summary of the results of the fluids tested for each property in comparison with the control groups.

Fluid	Mechanical			Visual check	Weight variation
	Tensile strength	Young modulus	Elongation at breakpoints		
Motor oil	↑	↑	↓	=	=
Valvoline Gear Oil	↑	↑	↓	=	=
Lubricating grease	↑	↑	↓	=	=
ATF Steering Fluid	↑	↑	↓	=	=
Brake fluid	=	↓	=	=	↑
Antifreeze coolant (50%)	↓	↓	↑	=	↑

Table 1 - Summary of the results obtained in the test

In relation to **mechanical properties**:

**Motor oil** did not show significant effects on PA12.

**Valvoline Gear Oil** did not induce a reaction with PA12.

**ATF Steering Fluid** did not attack or interact with PA12.

**Lubricating grease** did not affect PA12.

**Brake fluid** increased the weight of the sample by around 2%, but as the absorption of the brake fluid did *not* affect elongation, it did not react with PA12 as a plasticizer.

**Antifreeze coolant** slightly plasticized the samples.

Contact with all of the fluids affected the PA12 samples relative to their **surface appearances**.

In conclusion, **PA12 seems to be compatible with these fluids**, as no sample showed evidence of chemical reactions, stress cracking or solvation.

©Copyright 2018 HP Development Company, L.P. The information contained herein is subject to change without notice

The information contained herein is provided for information purposes only. The only terms and conditions governing the sale of HP 3D printer solutions are those set forth in a written sales agreement. The only warranties for HP products and services are set forth in the express warranty statements accompanying such products and services. Nothing herein should be construed as constituting an additional warranty or additional binding terms and conditions. HP shall not be liable for technical or editorial errors or omissions contained herein and the information herein is subject to change without notice.

## 2. Applications for MJF-printed parts

One of the key advantages of Additive Manufacturing in the automotive industry is in **fluid management applications**, including both fluid conduction and fluid storage, as in:

- **Part combination**

Combining multiple ducts into one reduces the risk of fluid leakages, assembly time and the amount of testing that needs to be performed once the parts have been assembled. Therefore, the overall performance of the subsystem can be increased while the total cost decreased.

- **Precise control of flow characteristics**

Through CFD (Computational Fluid Dynamics) simulations, the optimal performance of the fluid can be simulated and translated directly into the final manufactured part, reaching optimal fluid performance designs. Moreover, the flow characteristics of a given fluid can also be controlled by design. For instance, turbulent flows can be generated by introducing internal features; laminar flows can be improved by adding honeycomb structures; and turbulence can be mitigated by separating multiple flows inside a single duct.

- **Space optimization**

Complex geometries can be manufactured at no additional cost to maximize the space optimization when storing fluids under the hood. Existing industrial customers have used these strategies to generate additional space for added machine functionalities.

The main requirements for these applications are as follows:

- Printed parts need to be **chemically compatible** with the fluids in contact with them.
- Printed parts need to be **fluid-tight** at the operating temperature and pressure of the application.
- The overall manufacturing solution needs to be **economically viable** and meet **automotive industry qualification standards**.

This investigation focuses on testing the chemical compatibility of HP 3D High Reusability PA12 with the most common automotive fluids, with a special focus on electric vehicles.

To validate the fluid tightness of several geometries and wall thicknesses you can refer to the [HP Fluid tightness characterization](#) whitepaper [1].

### 3. Test Overview

In order to validate the chemical compatibility of HP 3D High Reusability PA12, it has to be determined if any type of chemical attacks take place on the material. The main type of chemical attacks possible [2] are:

- **Plasticization / Solvation:** Plasticization is the intermingling of the solvent between the polymer chains, causing the polymer to become more ductile and flexible. Solvation is the unraveling of the intertwined molecular chains that make up a polymer, causing it to become liquid.

In order to determine whether any plasticization or solvation occurred, the weight variation (if any) and differences on elongation at breakpoints (if any) in the samples were measured.

- **Chemical reaction:** The breakdown of the backbone of the molecular chain of the polymer. The reduction in length of the molecular chains transforms the polymer and lowers its strength. The chemical attack by the chemical reaction causes decreased tensile strength and elongation at the same time, without maintaining its natural and inverse proportions.

A tensile test was performed to evaluate any changes in the material's mechanical behaviour. Some initial validation studies already exist, such as the chemical compatibility tables that prove and verify the initial compatibility [3], [4].

- **Stress cracking:** An ESC (Environmental Stress Crack) is said to have occurred when a cleavage appears in a portion of the intertwined molecular chains due to a concentration of localized stress.

To determine if this occurred in our tests, an exhaustive visual check was made to provide an initial verification if a visual crack was seen, as well as a posterior tensile test if no fracture was seen.

Here is a summary of the **properties** that were tested:

- **Mechanical property tests:** The properties that were measured were tensile strengths, Young modulus, and elongations at breakpoint, following the ASTM D 638 method (sample specifications are presented in the [Appendix](#)).
- **Visual checks:** We looked for stress cracks or and changes to the colors of parts.
- **Weight variation:** We tested for absorption and decreases in weight.

The **fluids** that were tested were:

- **Alcohols:** antifreeze coolant (50% ethylene glycol, 50% water)
- **Oils:** motor oil, Valvoline Gear Oil, ATF Steering Fluid, brake fluid
- **Grease:** lubricating grease

©Copyright 2018 HP Development Company, L.P. The information contained herein is subject to change without notice

The information contained herein is provided for information purposes only. The only terms and conditions governing the sale of HP 3D printer solutions are those set forth in a written sales agreement. The only warranties for HP products and services are set forth in the express warranty statements accompanying such products and services. Nothing herein should be construed as constituting an additional warranty or additional binding terms and conditions. HP shall not be liable for technical or editorial errors or omissions contained herein and the information herein is subject to change without notice.

### 3.1. Experiment design

An initial experiment was performed for four different fluids. [Motor oil](#), [Valvoline Gear Oil](#), [ATF Steering Fluid](#) and [lubricating grease](#) were tested with type-V tensiles for 4 weeks in a climatic chamber at 60°C to check their feasibilities.

Afterwards, a secondary test with two other automotive fluids—[antifreeze coolant](#) and [brake fluid](#)—were tested in order to gain more insight into PA12’s feasibility in the automotive field.

Climatic chamber conditions were the same in both tests. The main difference was that in the second test, a control group without fluid was added to the climatic chamber in order to differentiate the effect of the fluid from the effect of the temperature. Also, said test was performed with type-I tensiles, for variability.

**Test conditions** for these two tests can be seen below.

Printing conditions plot	1st experiment	2nd experiment
Tensiles type	Type V	Type I
Printer	HP 3D Jet Fusion 4200	HP 3D Jet Fusion 4200
Material	HP 3D HR PA12	HP 3D HR PA12
Print mode	Balanced	Balanced
Orientation	XY	Z
Cooling	Natural	Natural
Number of fluids	4	2
Fluids tested	Motor oil Valvoline Gear Oil ATF Steering Fluid Lubricating grease	Antifreeze coolant (50%) Brake fluid
Exposure	Immersion	Immersion
Number of samples	7 units	25 units
Control group(s)	7 type-V tensiles at ambient temperature	25 type-I tensiles at test temperature
Test temperature	60°C	60°C
Test duration	4 weeks	6 weeks
Drying time	1 day	5 days
Data analysis	Tensile strengths Young’s Modulus Elongation at breakpoints	Tensile strengths Young’s Modulus Elongation at breakpoints

*Table 2 - Test summary*

©Copyright 2018 HP Development Company, L.P. The information contained herein is subject to change without notice

The information contained herein is provided for information purposes only. The only terms and conditions governing the sale of HP 3D printer solutions are those set forth in a written sales agreement. The only warranties for HP products and services are set forth in the express warranty statements accompanying such products and services. Nothing herein should be construed as constituting an additional warranty or additional binding terms and conditions. HP shall not be liable for technical or editorial errors or omissions contained herein and the information herein is subject to change without notice.



*Figure 1 - Tensiles of test 1*



*Figure 2 - Tensiles of test 2*



*Figure 3 - Tensiles of test 2 in the climatic chamber*

©Copyright 2018 HP Development Company, L.P. The information contained herein is subject to change without notice

The information contained herein is provided for information purposes only. The only terms and conditions governing the sale of HP 3D printer solutions are those set forth in a written sales agreement. The only warranties for HP products and services are set forth in the express warranty statements accompanying such products and services. Nothing herein should be construed as constituting an additional warranty or additional binding terms and conditions. HP shall not be liable for technical or editorial errors or omissions contained herein and the information herein is subject to change without notice.

## 4. Test Results

### 4.1. Visual Checks

Visual evaluations can be used in conjunction with almost any test method when determining chemical compatibilities and can play an important role in determining the mechanism of a chemical attack.

This section evaluates any changes in color seen after the test in comparison with the baseline color. When the fluid corrodes the surface of a tensile, the internal part, which is darker than the exterior surface, is exposed and turns visibly discolored. This phenomenon allows us to assess if any chemical attacks have happened the surface of the part by directly comparing pictures of the tested and the control tensiles.

All images were taken at the same time and under the same lighting conditions to prevent any differences in color/intensity that would arise from these factors.

#### Test 1: Motor oil, Valvoline Gear Oil, ATF Steering Fluid, brake fluid

The pictures below show the visual check results for the oils and grease. The fact that some samples exhibit a darker color is attributed to the accumulation of oil on their surfaces.



Figure 4 – Baseline tensile sample



Figure 5 - Tensiles that were in contact with motor oil in Test 1- Type V



Figure 6 - Tensiles that were in contact with Valvoline Gear Oil in Test 1- Type V



Figure 7 - Tensiles that were in contact with ATF Steering Fluid in Test 1- Type V

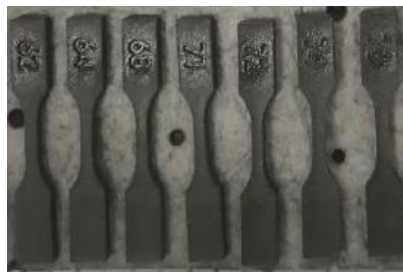

Figure 8 - Tensiles that were in contact with lubricating grease in Test 1- Type V

©Copyright 2018 HP Development Company, L.P. The information contained herein is subject to change without notice

The information contained herein is provided for information purposes only. The only terms and conditions governing the sale of HP 3D printer solutions are those set forth in a written sales agreement. The only warranties for HP products and services are set forth in the express warranty statements accompanying such products and services. Nothing herein should be construed as constituting an additional warranty or additional binding terms and conditions. HP shall not be liable for technical or editorial errors or omissions contained herein and the information herein is subject to change without notice.



## Test 2: Antifreeze coolant & brake fluid

As we can see in the following images, the tensiles showed an initial darkness, but over the passage of weeks, this darkness diminished. This is because of the slower drying rate of the fluid. After a month, the original color of the sample gradually came back, and no corrosion occurred.



Figure 9 – Baseline, antifreeze-tested, brake fluid -tested tensiles after climatic chamber



Figure 10 - Drying of brake fluid on tensiles

### Visual check performance summary

- ✓ No discoloration or color darkening occurred due to contact with any fluids. After complete drying, all the tensiles recovered their original colors. Therefore, no color impact occurred, at least not with the 4-week duration at 60°C.
- ✓ No surface corrosion was seen due to any of the fluids, as all samples show their original colors. After drying, the initial colors were recovered in all the tests.
- ✓ No visual stress cracking was seen on the surface of the tensiles.

©Copyright 2018 HP Development Company, L.P. The information contained herein is subject to change without notice

The information contained herein is provided for information purposes only. The only terms and conditions governing the sale of HP 3D printer solutions are those set forth in a written sales agreement. The only warranties for HP products and services are set forth in the express warranty statements accompanying such products and services. Nothing herein should be construed as constituting an additional warranty or additional binding terms and conditions. HP shall not be liable for technical or editorial errors or omissions contained herein and the information herein is subject to change without notice.

## 4.2. Mechanical Testing

In a chemical interaction, one of the main consequences is interference with the polymer chains of the given plastic, which likely reduces its mechanical properties.

To determine any possible changes in the mechanical behavior of the tensiles that were in contact with the fluids in the climatic chamber or possible solvation or plasticization, a tensile test was performed, evaluating the tensile strength, the Young's modulus and the elongation at breakpoints of the samples.

The following charts show the results each mechanical property for the fluids tested in comparison with the control zone created between the **control group (the orange line)** and the **datasheet values (the blue line)**.

### Tensile strength

The tensile strength of a material is the maximum amount of tensile stress that it can withstand before failure (for example: breaking).

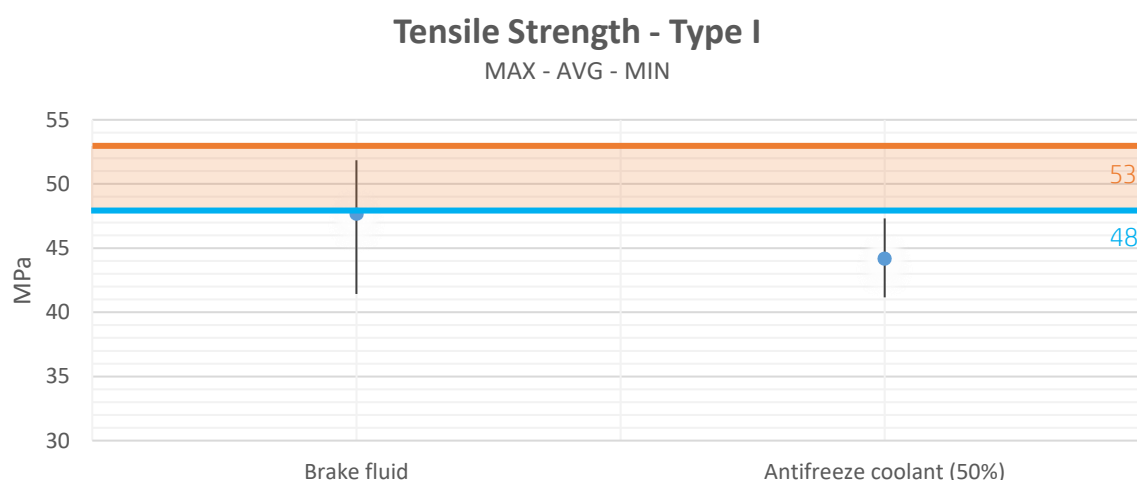
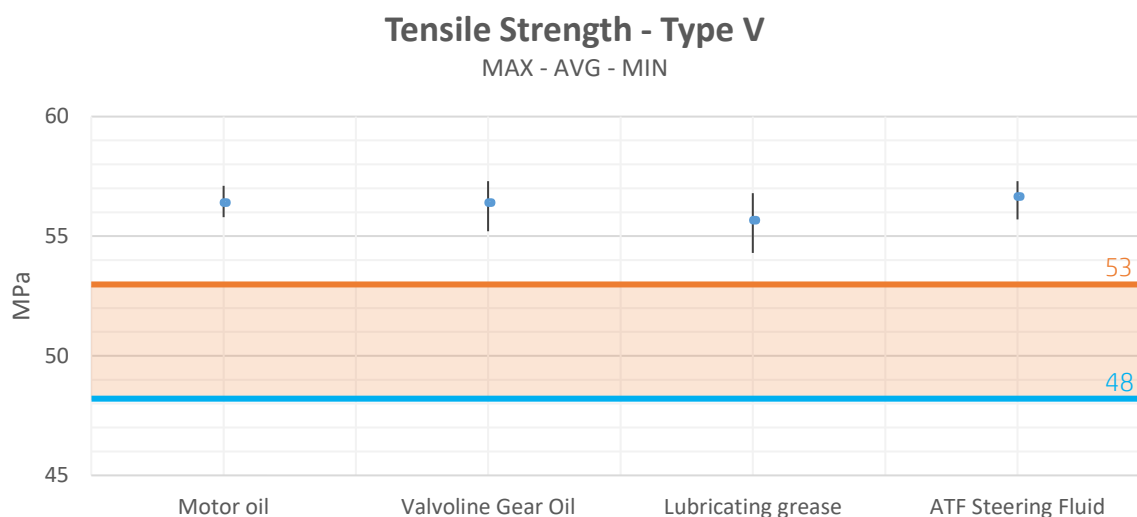

©Copyright 2018 HP Development Company, L.P. The information contained herein is subject to change without notice

The information contained herein is provided for information purposes only. The only terms and conditions governing the sale of HP 3D printer solutions are those set forth in a written sales agreement. The only warranties for HP products and services are set forth in the express warranty statements accompanying such products and services. Nothing herein should be construed as constituting an additional warranty or additional binding terms and conditions. HP shall not be liable for technical or editorial errors or omissions contained herein and the information herein is subject to change without notice.

The tensile strength values obtained after the heating process in test 1 show that there were no negative interactions with most fluids ([motor oil](#), [Valvoline Gear Oil](#), [lubricating grease](#) and [ATF Steering Fluid](#)). No variations seemed to appear when the samples were in contact with [brake fluid](#) either.

Only with [antifreeze](#) did the strength of the samples decrease.

### Young's modulus

Young's modulus characterizes how difficult it is to deform a material in terms of elastic behavior. As in the previous subsection, the following charts show the test values obtained with the datasheet (the blue line) and the control group values (the orange line).

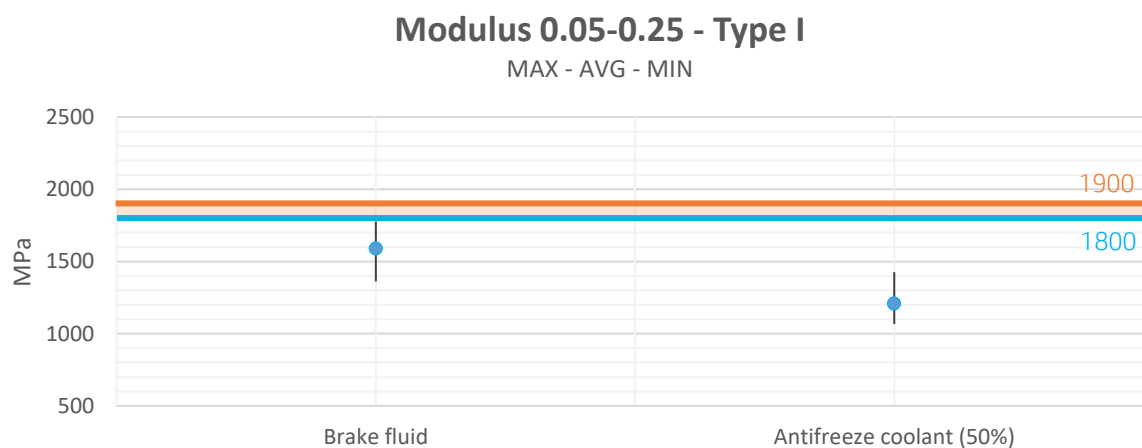
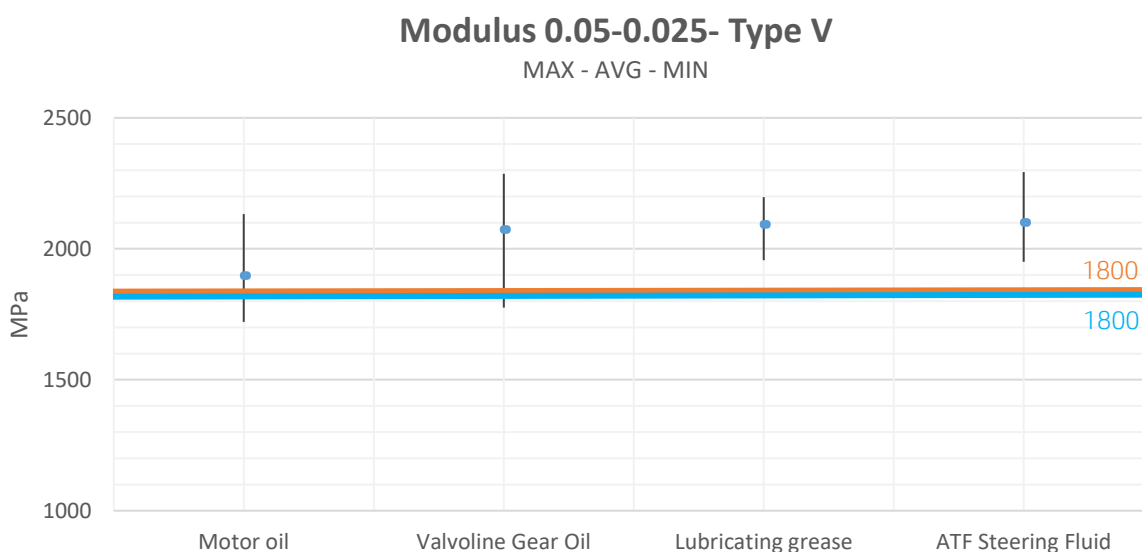

[Motor oil](#), [Valvoline Gear Oil](#), [lubricating grease](#) and [ATF Steering Fluid](#) increased the materials' strengths and their Young's moduli slightly with respect to their natural values.

[Brake fluid](#) and [antifreeze](#) decreased the materials' Young's moduli.

©Copyright 2018 HP Development Company, L.P. The information contained herein is subject to change without notice

The information contained herein is provided for information purposes only. The only terms and conditions governing the sale of HP 3D printer solutions are those set forth in a written sales agreement. The only warranties for HP products and services are set forth in the express warranty statements accompanying such products and services. Nothing herein should be construed as constituting an additional warranty or additional binding terms and conditions. HP shall not be liable for technical or editorial errors or omissions contained herein and the information herein is subject to change without notice.

## Elongation at breakpoints

The elongations at breakpoints were studied in order to evaluate whether the fluids had any effect on the plastic behavior of the material. Plasticization tends to soften polymers, increasing their ductility and thus causing an increase in elongation, while at the same time lowering their tensile strengths and Young's moduli.

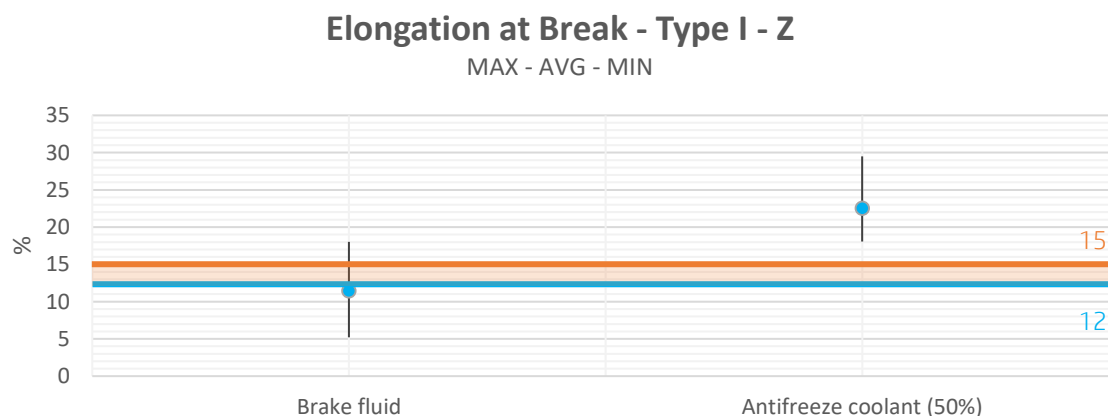
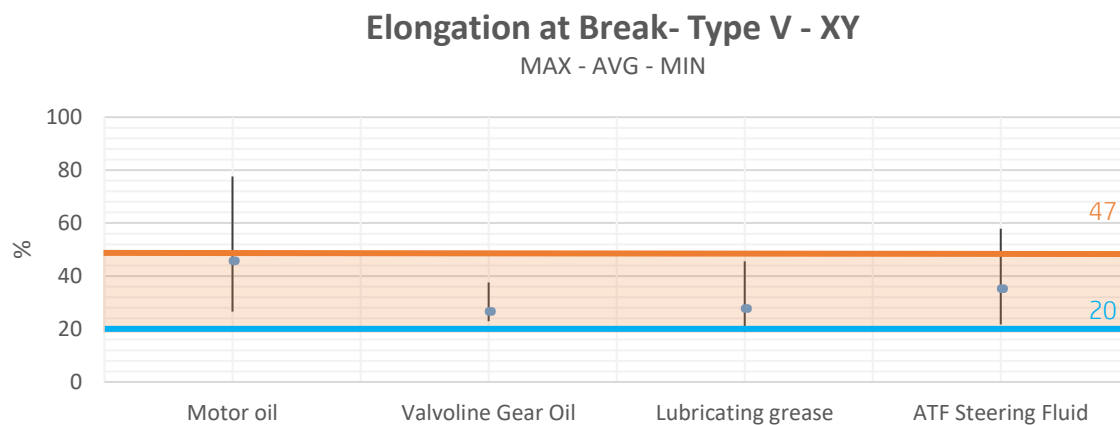

Concerning [Valvoline Gear Oil](#), [lubricating grease](#) and [ATF Steering Fluid](#): Elongation values were between the control group values and those of the datasheets.

As can be seen, the average value for the tensiles which were in contact with [motor oil](#) was also in the control zone. The main difference with the other results was the range of the values obtained, which was wider compared to the results of the other groups and reached a maximum near 80% of elongation. This high variability could be due to the measurements of the type-V tensiles. However, as the average value is *under* the baseline and *in* the control zone, we can consider that contact with motor oil does *not* have a significant effect on this mechanical property.

[Brake fluid](#) did not cause any alterations to the samples (in terms of elongation) either.

[Antifreeze](#) produced an *increase* in the elongation, which reaffirms the natural behavior because the tensile strengths and Young's moduli both decreased. They were inverse to the elongation at breakpoint. If *all* the properties increased or decreased at the same time, this would mean that a *sure* chemical reaction had occurred, but this is not the case, as only a plasticizing phenomenon took place. This will be confirmed in the weight absorption analysis.

©Copyright 2018 HP Development Company, L.P. The information contained herein is subject to change without notice

The information contained herein is provided for information purposes only. The only terms and conditions governing the sale of HP 3D printer solutions are those set forth in a written sales agreement. The only warranties for HP products and services are set forth in the express warranty statements accompanying such products and services. Nothing herein should be construed as constituting an additional warranty or additional binding terms and conditions. HP shall not be liable for technical or editorial errors or omissions contained herein and the information herein is subject to change without notice.

### 4.3. Weight Variation

“Physical properties such as the change in volume, weight, or dimensions, are particularly useful when evaluating types of chemical attack associated with solvation or plasticization. Solvation dissolves the polymer; therefore, weight loss and softening will occur as the polymer becomes a solute [2].”

Weight variations were studied to evaluate if the tensiles experienced any solvation or absorption. Particularly, absorption could lead to plasticization, so it was important for us to measure the increase in weight and how it affects the mechanical properties.

In the following tables, the initial and final weights are shown, together with the absorption values. Weight measurements were taken after 1 day of drying.

Experiment 1	Weight Tensiles type V			
Fluid	Before (g)	After (g)	Absorption (g)	Absorption %
Motor oil	20.62	20.652	0.032	0.16
Valvoline Gear Oil	20.7	20.756	0.056	0.27
Lubricating grease	20.59	20.887	0.297	1.44
ATF Steering Fluid	20.717	20.782	0.065	0.31

Table 3 - Weight variation of tensiles in test 1- Type V

Experiment 2	Weight Tensiles type I			
Fluid	Before (g)	After (g)	Absorption (g)	Absorption %
Brake fluid	214.88	219.69	4.81	2.24
Antifreeze coolant (50%)	215.1	222.25	7.15	3.32

Table 4 - Weight variation of tensiles in test 2- Type I

Regarding the samples that were in contact with oils ([motor oil](#), [Valvoline Gear Oil](#), [ATF Steering Fluid](#)): absorption was negligible.

As far as the tensiles that were in contact with [lubricating grease](#), their weight increased by 1.4%, but this was most likely induced by the remaining grease on the surface that couldn't be removed.

The tensiles that were in contact with [brake fluid](#) increased in weight by around 2%, but as we have said, the absorption of the brake fluid did *not* affect elongation, so it did *not* react as a plasticizer.

[Antifreeze](#) is the fluid that induced the most absorption. This is due to its lower viscosity, which facilitates the penetration into the tensile. As previously seen, it is also the fluid that resulted in the most elongation. Plasticization allows for movement of the individual molecular chains of a polymer, causing it to become increasingly flexible as more plasticizer is absorbed. Our samples took on a darker pigmentation that was lost after drying. This proved the absorption of the antifreeze but its subsequent evaporation. Therefore, we can confirm that antifreeze coolant acts as a plasticizer with PA12.

©Copyright 2018 HP Development Company, L.P. The information contained herein is subject to change without notice

The information contained herein is provided for information purposes only. The only terms and conditions governing the sale of HP 3D printer solutions are those set forth in a written sales agreement. The only warranties for HP products and services are set forth in the express warranty statements accompanying such products and services. Nothing herein should be construed as constituting an additional warranty or additional binding terms and conditions. HP shall not be liable for technical or editorial errors or omissions contained herein and the information herein is subject to change without notice.

## 5. FAQ (Internal Only)

### *Why didn't you perform all the tests with type-V tensiles?*

For the second experiment we changed from type V to type I because **type-V tensiles showed a higher variability** in the traction test. This is due to the cross-area on a type-V tensile, which is smaller than for type-I tensiles. During the traction test, the optical extensometer had less data per cross-section and it gave problems with the reading, throwing more errors and resulting in more deviations in sample results.

### *Why didn't you perform all the tests with tensiles oriented in the same direction?*

After the first experiment, we could see that the **elongations at breakpoints showed more variability**. This could have been due to the orientation of the samples when printed.

As the tensiles oriented in the XY-plane had layers along said axis and during the tensile test these layers were extended, increasing their elongation, tensiles printed along the Z-axis had their layers perpendicular to their cross section, and this fact gives less variability in the cross-sections. Therefore, results are much more statistically robust as we have tested them.

### *Did the orientation of the tensiles / pieces in the bucket change their properties?*

Yes, **tensiles from the top layer of the bucket** were not used in this test because their elongation at breakpoint values are known to be noticeably higher. This is due to the microstructure of the PA12 and its crystallization time. Since these parts cool down quicker than lower layers, lower cooling times imply less crystals formed, so they are more amorphous. Amorphous parts yield more elongation but less tensile strength and a lower Young's modulus than a more crystalline part.

### *Did you do the experiment with wiper washer fluid?*

Yes, but due to its water base and the design of the experiment (no rotational fluid) the **wiper washer was evaporated**. If required, it would be necessary to perform the experiment in a saturated climatic chamber to prevent evaporation or to design the experiment in pipes to prevent evaporation.

## 6. References

- [1] HP, HP White paper: MJF Applications - Fluid tightness characterization, 2018.
- [2] "Intertek," Plastics technology laboratories, [Online]. Available: <http://www.ptli.com/antec4.asp>. [Accessed 28 August 2018].
- [3] LNP Engineering Plastics.
- [4] J. H. J. G. S. M. Michael Bolgar, Handbook for the Chemical Analysis of Plastic and Polymer Additives.

## 7. Appendix

ASTM D638 specimen dimensions:

Size	Type I	Type V
Full length, $l_3$	165	-
Parallel length, $l_2$	57	63,5
Gauge length, $l_1$	50	7,62
Parallel section width, $b_1$	13	-
Thickness, $h$	Recommend $3.2 \pm 0.4$ mm 7 mm to 14 mm	4 mm or less
Grip section width, $b_2$	19	9,53
Distance between grips	115	25,4

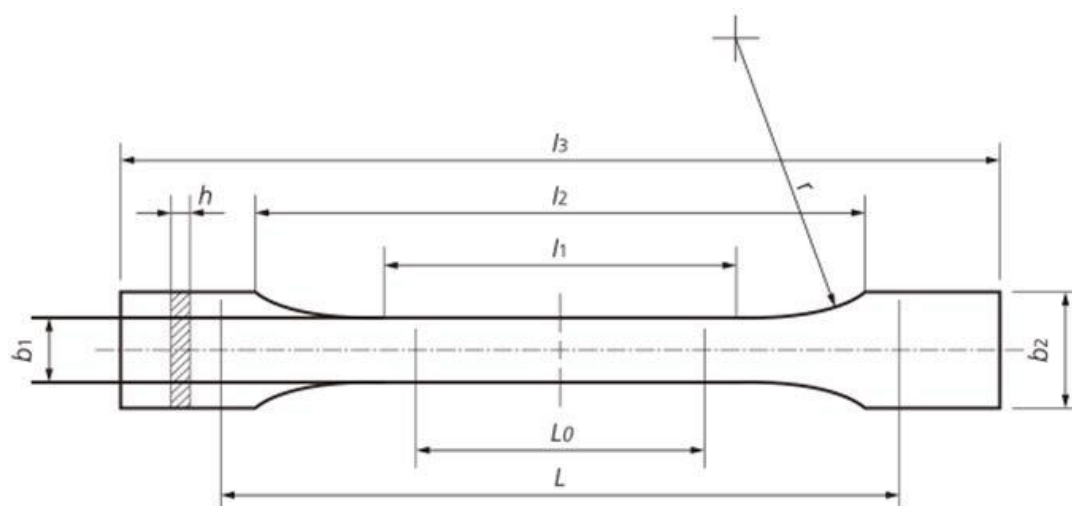

©Copyright 2018 HP Development Company, L.P. The information contained herein is subject to change without notice

The information contained herein is provided for information purposes only. The only terms and conditions governing the sale of HP 3D printer solutions are those set forth in a written sales agreement. The only warranties for HP products and services are set forth in the express warranty statements accompanying such products and services. Nothing herein should be construed as constituting an additional warranty or additional binding terms and conditions. HP shall not be liable for technical or editorial errors or omissions contained herein and the information herein is subject to change without notice.